

Course Design Guidelines for the TDAA

This is a document under development. I realize when reviewing courses that much of what I see, and frankly most of what I might object to, is based upon my own conceptions of design fairness and the expectation of performance from a dog and handler.

One of the greatest difficulties in the TDAA today is that our courses are designed too tightly. This document will seek to address how we think about spacing between obstacles, and perhaps begin to approach a definition for what kinds of challenges are appropriate for each level of competition in the TDAA.

The tight courses discourage players with rather good dogs from the other venues, who might otherwise be real fans of the TDAA. They, somewhat rightly, view the challenges of this venue as inappropriate or perhaps unsafe or unfair.

Appropriate Class Challenges

We have over 20 years of experience in this country designing courses for agility. Much of what we see out in the real world is applicable to course design for the TDAA. Most agility organizations have a rational standard for what kind of challenges they require in coursework at the different levels.

The TDAA has no firm rule that says certain challenges, in any given number, must appear on course for the three levels of play. This encourages our judges to bring in challenges that they've seen in the world and apply them in course design without feeling obligated to force any challenge.

A good course will include one or two key challenges. It's not necessary to throw every challenge you have in your bag of tricks into every course. And challenges should be appropriate to the level of the dogs competing. Use your common sense. What skills would be required of a Beginner dog? What of the Intermediate? And, what of the Superior dog?

In general it's a good idea to design for flow. This means that the course should allow the dog to get up to full speed without being jerked back and forth in relentless fashion. Flow breakers include: Technical obstacles (contacts, and weaves); the table; and, turns (mindful that the degree of turn has an inverse proportional relationship to the break in flow).

Challenge	Beginner	Intermediate	Superior
Tunnels under Contact Obstacles	No	OK	OK
Discrimination Challenges (two or more obstacles placed in close proximity)	Rarely	OK	OK
Angled Approaches	Modest	OK	OK
180° Turns	Modified	OK	OK

270° Turns	No	Rarely	OK
Shaped Approaches	No	Rarely	OK
Long Straight Lines	No	Rarely	OK
Turning to the Dog	Rarely	OK	OK
Side Changes to Dog	0-1	1-3	3-4
Dummy Obstacles	No	Rarely	OK
Number of Obstacles in Standard	X	X	x

For the Beginner class it's important to understand that the chief test is whether the dog knows how to do the equipment, and can follow a handler's lead. With this in mind, most eventful challenges that might be posed to higher level classes go beyond the basic requirements for challenging the Beginner dog.

Distance between Obstacles

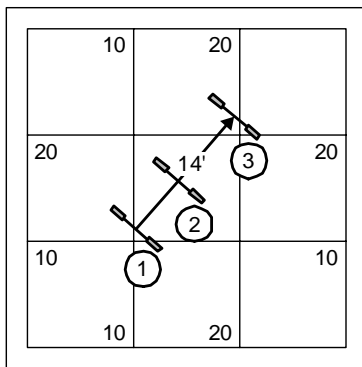

It is acceptable in a straight-away series of jumps to have an average transitional distance between obstacles in the range of 6' to 8'. This actually encourages some of the big dogs in the TDAA (the 12" and 16" dogs) to *bounce* between the performance of jumps.

The 12' Rule (minimum)

There are certain challenges which require a minimum approach of about 12'. When I say minimum... that really means that there could be, and probably should be... more.

The evident list of challenges requiring a 12' minimum might include the following:

- Approach to a contact obstacle or the weave poles
- A transition between obstacles that requires a turn of 90° or more
- A trap or option (obstacle discrimination, for example)
- A dog coming out of a tunnel, regardless of what is the next obstacle

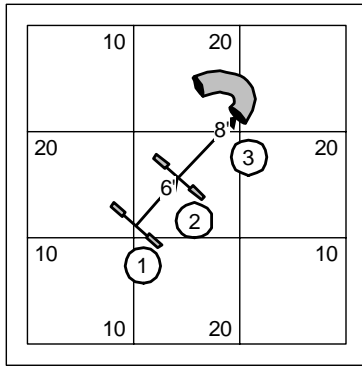

It would be permissible in this sequence to present the terminal obstacle in the line as a tunnel or a contact obstacle, so long as the approach is square.

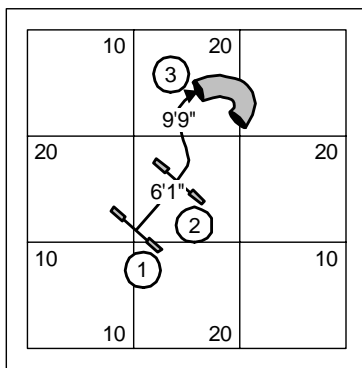

It is unfair to the dog to present a wrong-course option and give only 6 or 8' for the handler to effect the turn away from that option, as shown in this picture. While the measured distance to the opposite side entry to the pipe tunnel might be only about 10', the option presented to the dog was a short 8'.

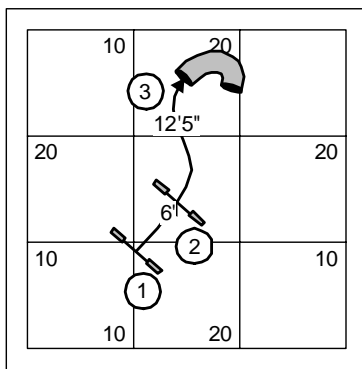

The opposite side pipe tunnel entry is fixed by giving at *least* 12' for the handler to solve the change of directions.

Turning Radius

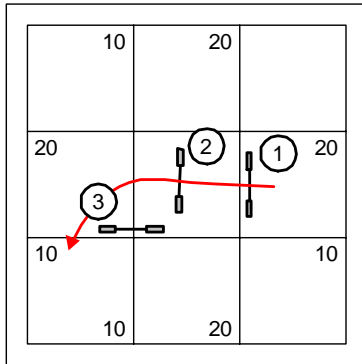

This drawing indicates what happens to a faster and long-striding dog when not enough room has been given to make the turn. This is simple physics. The dog cannot make the turn.

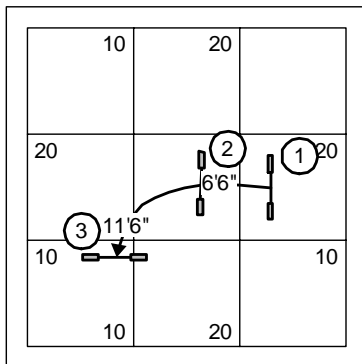

When the dog is required to turn after an obstacle we should add about 1% in distance for every 2° of turn. So if the average distance between obstacles in a straight line is 8'... then in a 90° the distance should be a minimum of just 12'.

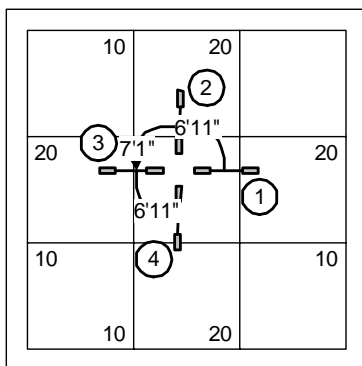

The implications for providing enough room for a dog's turning radius are important. We see too often in the TDAA pinwheels in which only a Yorkie could truly succeed. This is not adequate for the bigger and faster dogs.

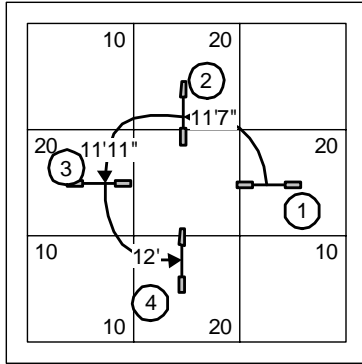

So the pinwheel needs to be opened up spaciouly giving the dog adequate room to turn and, frankly, giving the handler a bit of operating room in and about the jumps.

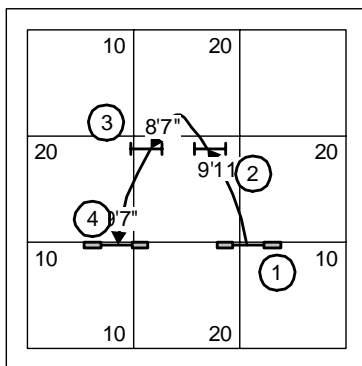

The simple 180° also requires adequate room for the dog's turning radius. We see transitions that are too short especially when jumps without wings are used in competition (which is often the case). While it looks like we've given the handler room to step between the jumps, the dog is apt to forge around the jump if he is moving with any electricity whatsoever.

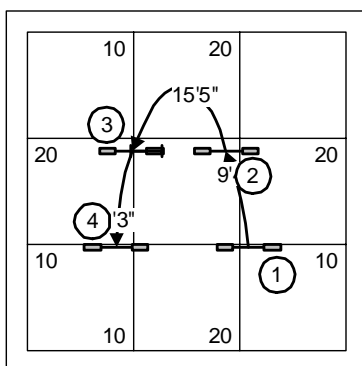

If we add wings to the jump and still provide room for the handler to move between them, the turning radius for the dog is opened up considerably.

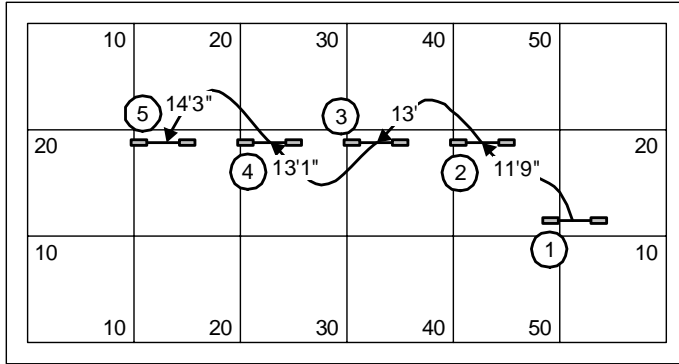

If we apply the same logic to a serpentine of jumps, the course designer should provide about 9' to 10' from center of jump to center of jump. Note that with 18" wings on the jumps this leaves enough room that even a wheelchair might pass between the jumps. But again, where we tend to lose focus on the proper spacing between jumps is when we aren't using winged hurdles. So an easy way to remember the proper spacing is to visualize each jump with a wing; and room still provided for the handler to move in and out of the jumps.

Square approaches

In the standard classes it is the handler's job to square up the approaches to obstacles so that performance is safe and fair to the dog. Those obstacles that *require* a square include:

- Any contact obstacle
- The Tire

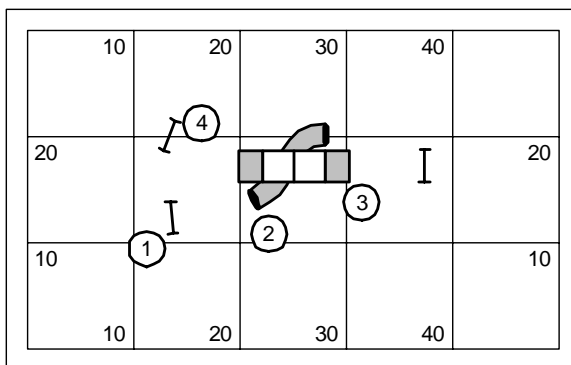

This is a sequence that probably shouldn't be allowed at any level. The flow violates a specific rule of the *option* (discussed elsewhere in this document). The dog should be given a minimum of 12' for the turn in the presence of an option. Further, the short transition between the pipe tunnel and the A-frame actually encourages the handler to give the dog inadequate room to make the turn.

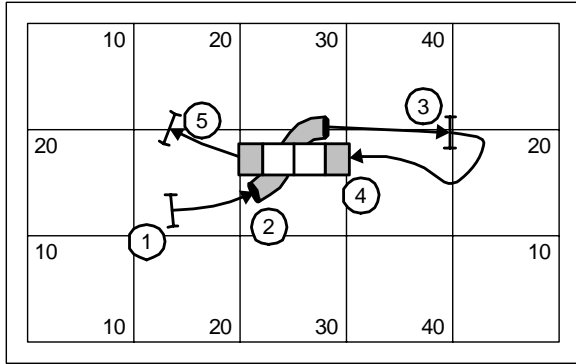

This problem could be solved by pushing the dummy jump back 6' or so from its location. Or, simply include the jump in the sequence to bring the dog back fair and square to the A-frame. Note that I moved the jump slightly to square up for the exit from the pipe tunnel and frankly still provided about 12' for the approach to the jump.

While as a course designer it's your job to create square approaches to obstacles in a standard course, the square approach is problematic in a dog's choice game (in which the dog can be directed to the obstacle of the handler's choosing). It might be worthwhile during any dog's choice games to include in your briefing a warning that the handler is the architect of the dog's path given any approach to a contact obstacle. Consequently special faults might apply for a handler who thoughtlessly creates a dangerous approach or gives insufficient room for the dog to get up and over the contact.

Laying Out the Field

Aside from the obvious intellectual challenge of designing an appropriate agility challenge for standard courses and games, you should also take into account aesthetic and practical design considerations. Following is a simple list that the skillful course designer will consider. More comprehensive discussions follow:

- Balance the course in the available space
- Separate start and finish obstacles
- Table should appear in middle "third" of the course
- Position contact obstacles for reasonable judges path
- Nest courses between levels and with games
- Consider the timekeepers position when establishing start and finish lines

Balancing the Course

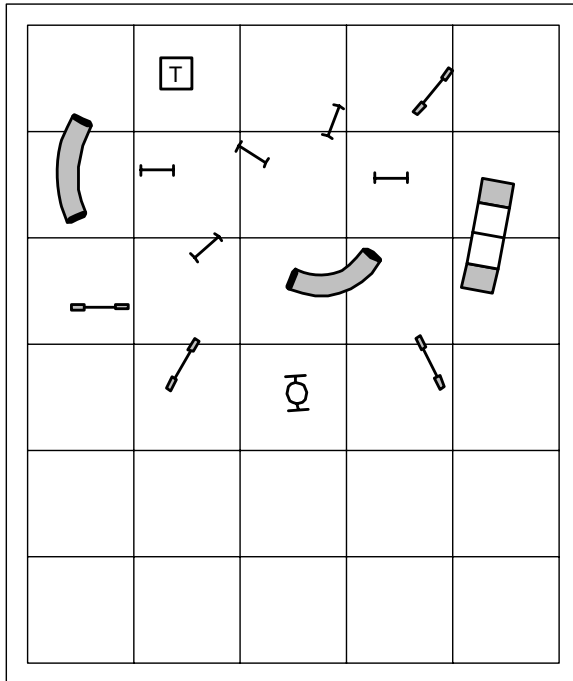

The equipment should be arranged on the field in such a way that it is balanced and nearly artistic. Consider the arrangement of obstacles shown here. Everything is pretty much jammed to the back of the field and frankly does not make for a very pleasing arrangement.

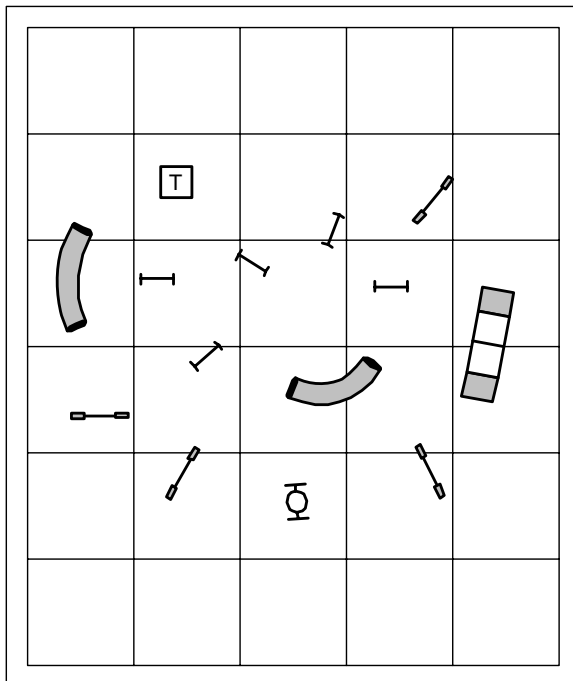

While this is the identical arrangement of obstacles... you'll note that balancing it in the available space makes it all seem less crowded and considerably more pleasing from an

artistic point of view.

Separate Start and Finish Line

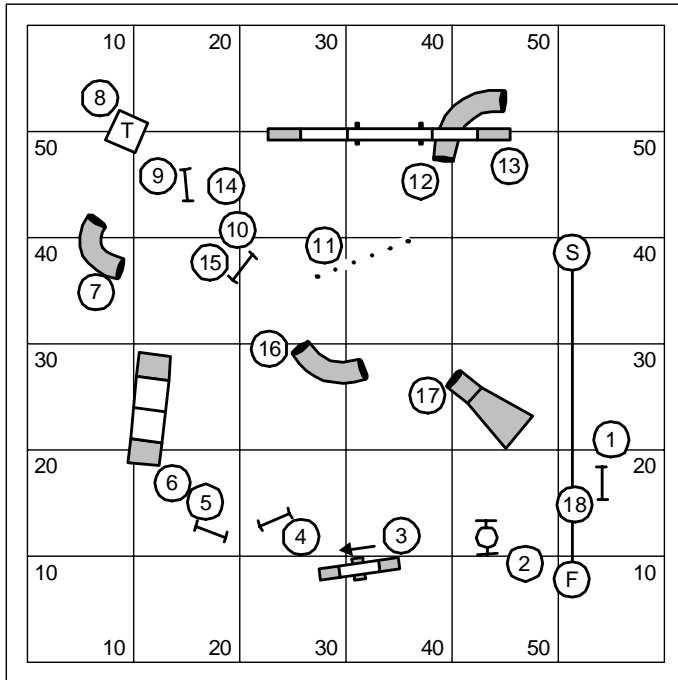

The difficulty with this course is that it starts and stops at the same obstacle. It will be impossible for the next dog to be ready at the line to go if the dog in front will be finishing coming over the start jump. This is a problem of efficient time management. If a handler cannot approach the start line with his or her dog... the class will take longer to run than is necessary.

It is best that the start and finish lines are widely separated.

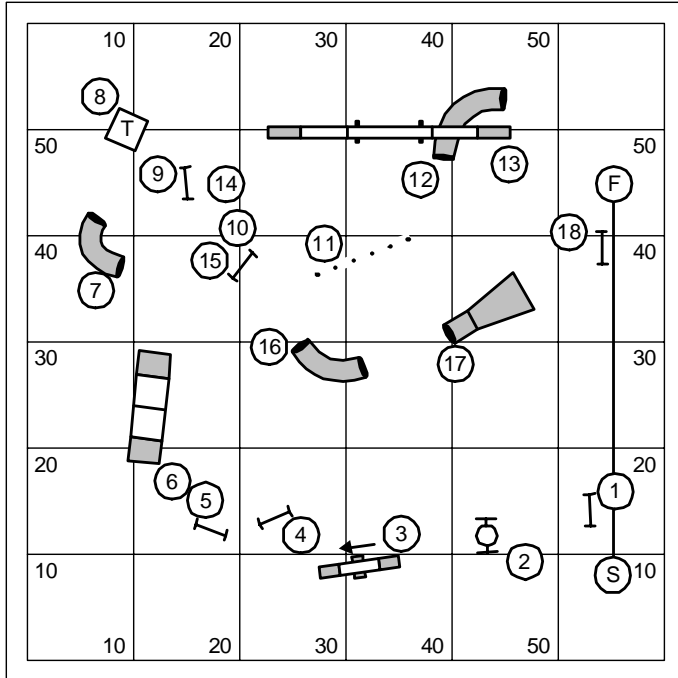

This can be cured easily by redesigning the finish to draw the dog away from the start and finish at a comfortable distance.

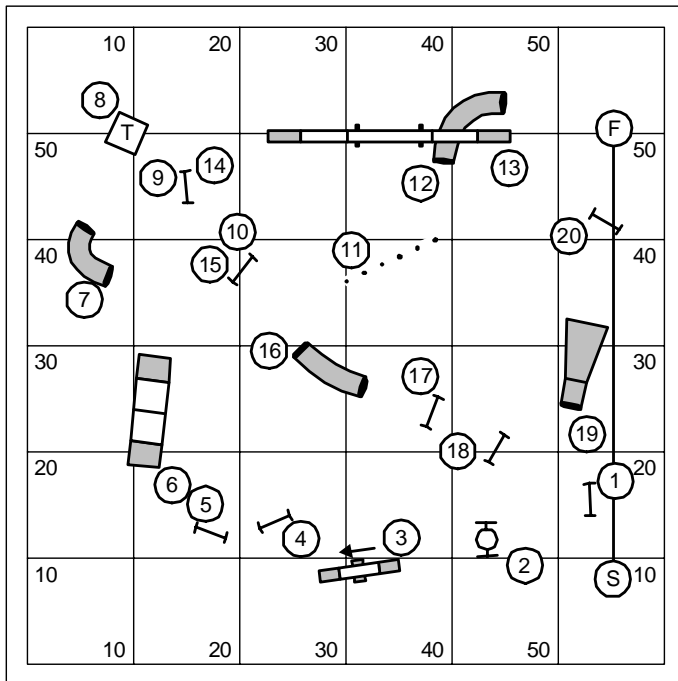

Presenting the starting obstacle as an option to the dog is just about the same problem as making the last obstacle the same as the first obstacle. The handler awaiting the dog on the field cannot really trust that the dog ahead of him is *not* going to take the wrong course option... and so won't be able to approach the line in a timely manner.

It actually could be more of a difficulty if the handler on line doesn't consider that the

dog ahead in line could take the wrong-course option... and that's exactly what happens. Now two dogs are set up for a possible collision; and nothing really good can result from this problem.

Nesting Courses

While the following discussion of Perfect Nesting was written in the context of course design for another agility organization, the principles apply strongly to the TDAA. We play a lot of games each day, and sometimes entry is quite low. Consequently it's possible to spend more time building courses than actually running dogs. Things will move along more quickly if the course designer has an eye for *nesting* courses in such a way that the movement of equipment is kept to an absolute minimum.

* * *

Perfect Nesting is the practice of the course designer wherein courses for different levels of competitors are run on a set-up that is not altered or changed in any way... except for placement of the numbering cones.

This is a wonderful practice for the judge of a small trial in which the time spent in setting up the different courses might outweigh the time spent by dogs running the courses. So perfectly nested courses

This is also an important practice for those of us who run agility **leagues** for different levels. We don't want to move the equipment between levels (because dogs at all levels will run in nearly every league play session)... and we don't want to move equipment between *league play* and class.

Attached are a suite of courses including a standard course for three levels, and then gamblers courses for three levels. With the possible exception of the size of the playing field, the equipment specs concur with the required equipment for USDAA competition.

To be real... in the Starters standard course I would likely dispense with obstacles that are not used in the course. I don't much believe in dummy obstacles; feeling that they are a bit of a ham-handed convention on the part of the course designer. I've colored these obstacles **red** indicating that in a real USDAA competition they would probably be removed. However, in league play there are not qualification implications, so these devices would help separate the field.

Starters Standard

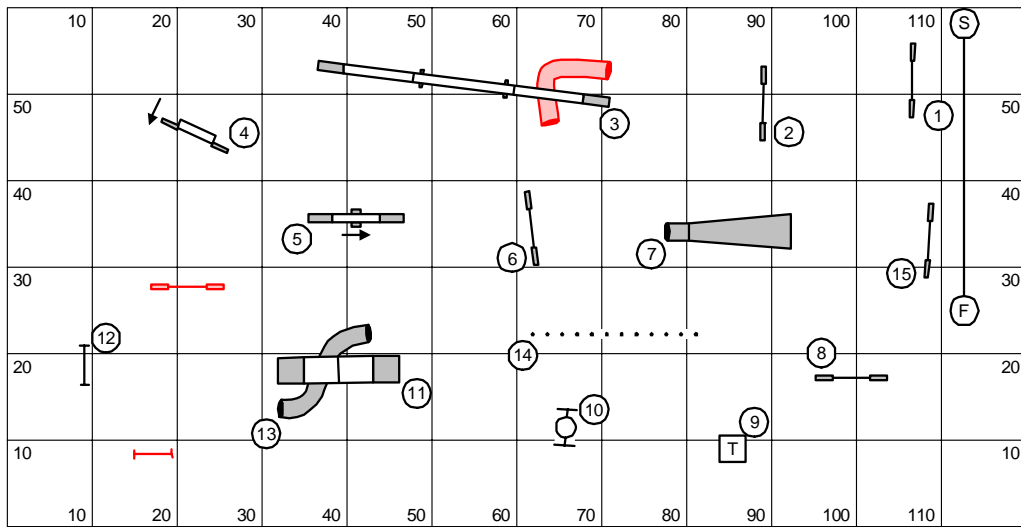

Advanced Standard

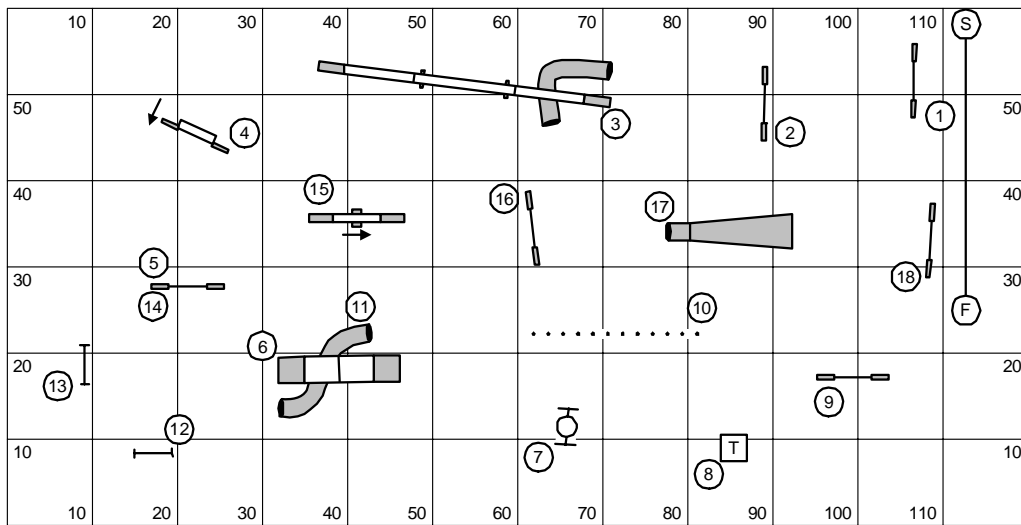

Masters Standard

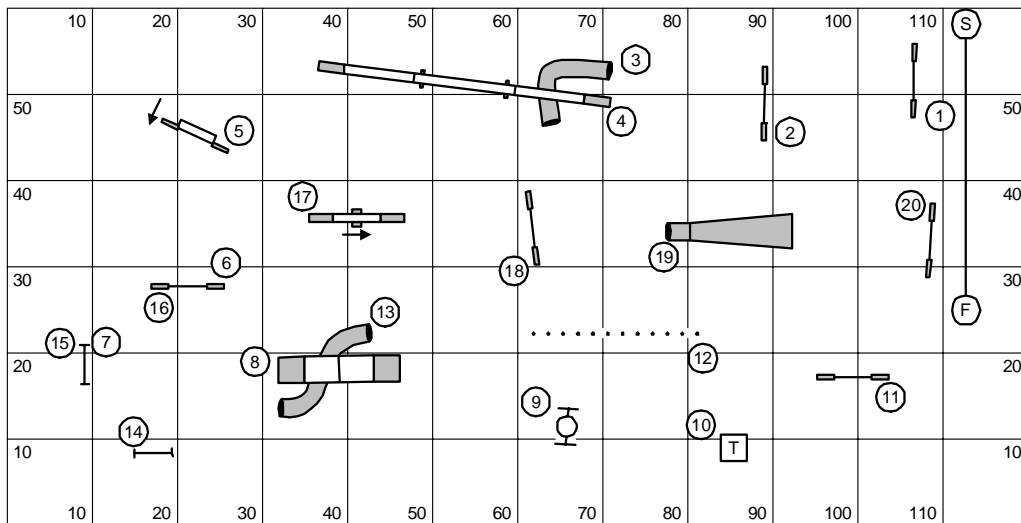

Starters Gamblers

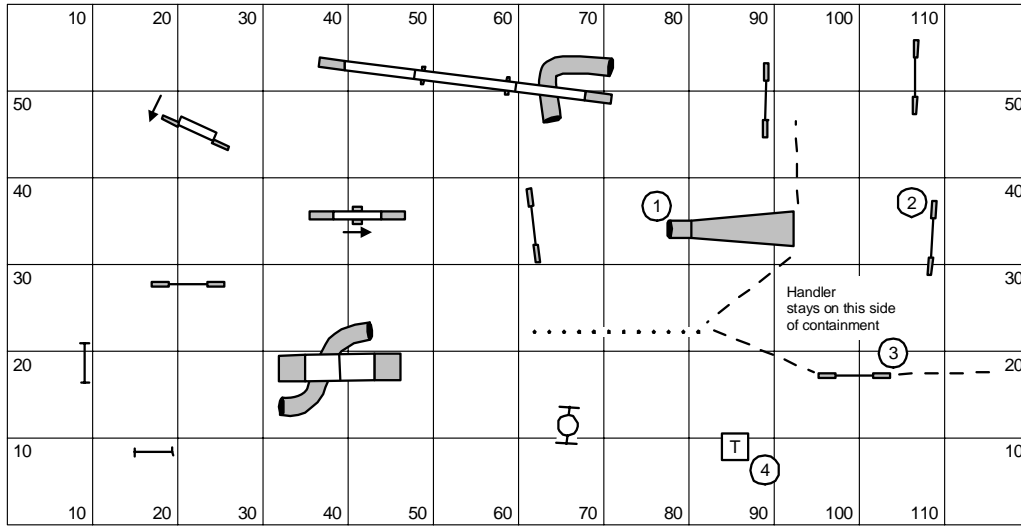

Advanced Gamblers

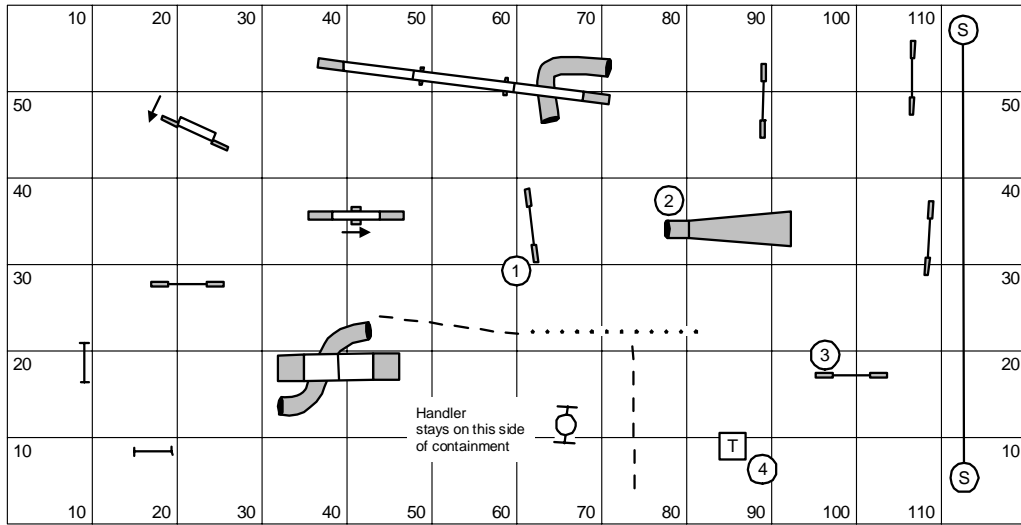

Masters Gamblers

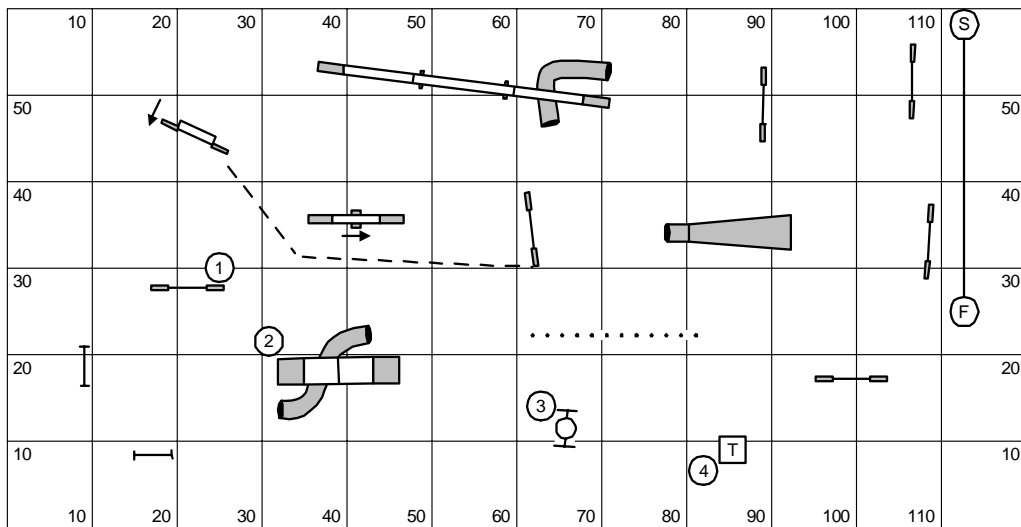

Preparing the Course Map

There is an expectation in dog agility these days that exhibitors will have a course map for each standard course and game to be played. Since the TDAA has a high reliance on games, it should be a standard courtesy to exhibitors to make a course map available along with very detailed briefings for every game. This truly is a matter of running an efficient trial. The exhibitor should be able to grasp the rules of a game and calculate a handling strategy, without having to do so after a briefing, relying on the limited time for a walk-through.

Other dog agility venues can be quite specific about the type of information that is included on the course-map. For example, a judge might be required to show the precise position of the time-keeper and scribe, judge's path and handler's path, and perhaps even discrete distances between obstacles. While the TDAA might someday be equally specific and arduous and persnickety in our definition of the course map... for now we pretty much leave it up to the judge.

The following discussion details attempt to establish a rational definition for the course map as basic documentation. While we aren't trying to establish a standard, these are all details that should occur to the course designer.

Border around the course

You'll note that in this document most courses include a 2' border around all edges of a course map. This isn't required at all. But note that it is an attractive presentation.

One edge of the course map should be reserved for identification and briefing purposes.

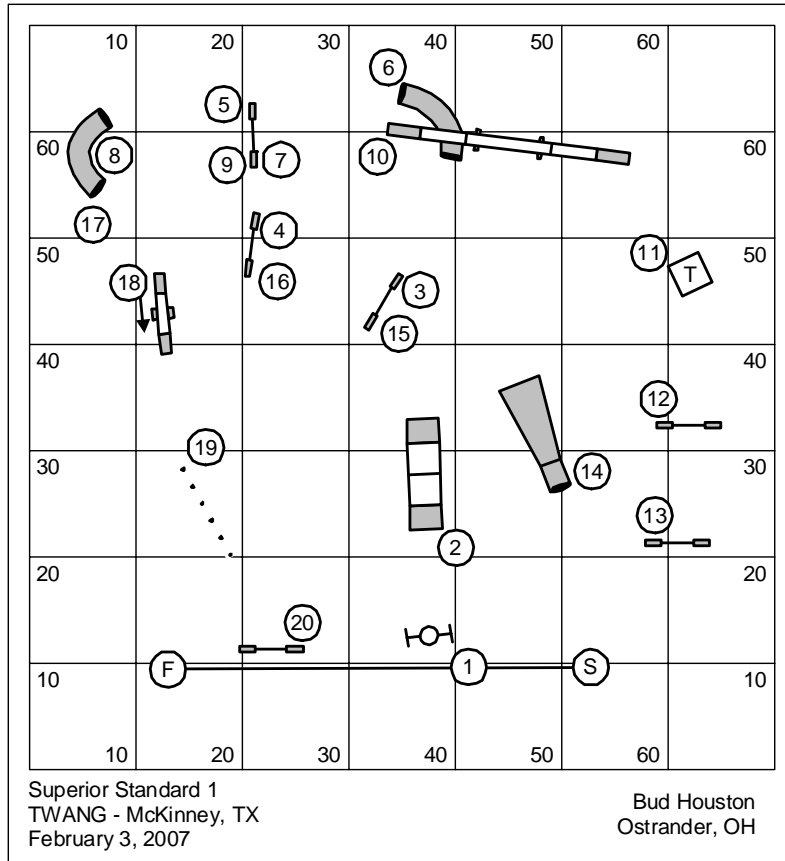

In this course 9' have been reserved at the bottom of the course map for documentation purposes. This allows the course designer to keep documentation text *off* of the field, and to the side, where it belongs.

I've seen courses by TDAA judges on which the numbering begins in the center of the field, and numbers outward, towards either edge. This is actually a convention that is made available through Clean Run Course Designer for **course builders** who are using the *baseline method* for building courses. It is appropriate *only* for course builders, and *only* when the baseline method is being used (you should establish that fact before printing courses).

Numbering and grid-lines

Gridlines should always appear on the course map. This allows course builders to use the standard 10' intervals to triangulate the position of obstacles on the field. Note that for exhibitors the numbering begins in one corner, and extends across the field on X and Y axis.

Information that should be provided for the exhibitor

For standard courses at a very minimum the information provided on the course map

should include:

- Class
- Date
- Name of the Club
- Location
- Judge's Name

When designing games it might be a good idea to include a variety of other information. If the game is simple enough you might provide the entire briefing. But at a minimum you might provide the course time and qualifying requirements. And, in cases where obstacles have different values, you might provide the values of those obstacles.

Numbering Obstacles

Briefing

Designing around Poles

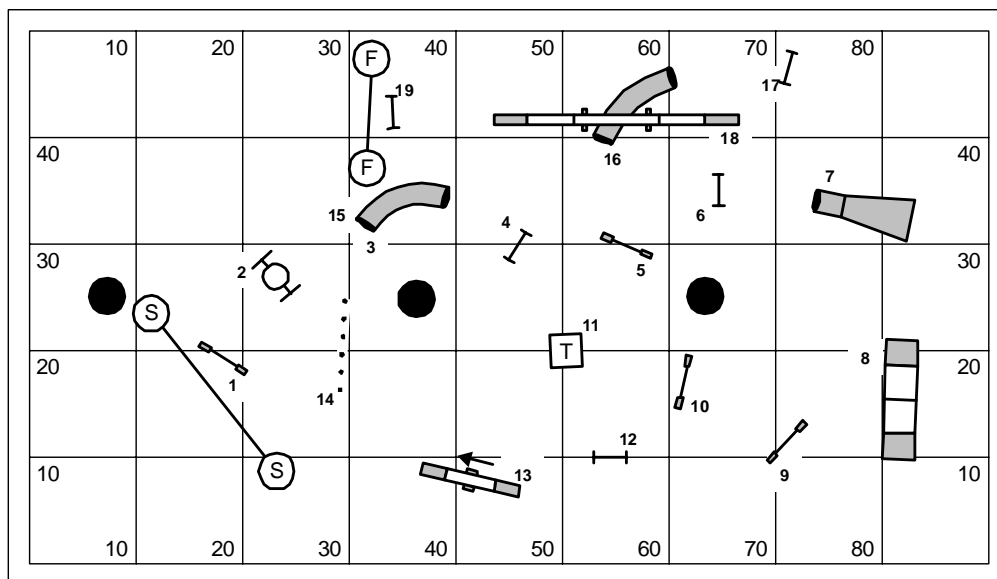

A number of venues in the TDAA conduct trials in facilities that feature poles, presumably for load-bearing purposes. The real difficulty with poles is that they might limit options for *flow* and certainly may impact the *balance* of the course. The most important considerations from the course designer's point of view are these:

- The handler should be given an adequate path to get past any pole;
- A pole should not limit handling choice; and
- The pole should not obscure the obstacle to the dog

In the course illustrated above you'll note that the handler has been given plenty of working room on *either* side of each obstacle to conduct a handling plan without running into any of the poles.

It might be useful in advance of a trial to ask exactly how big are the poles.

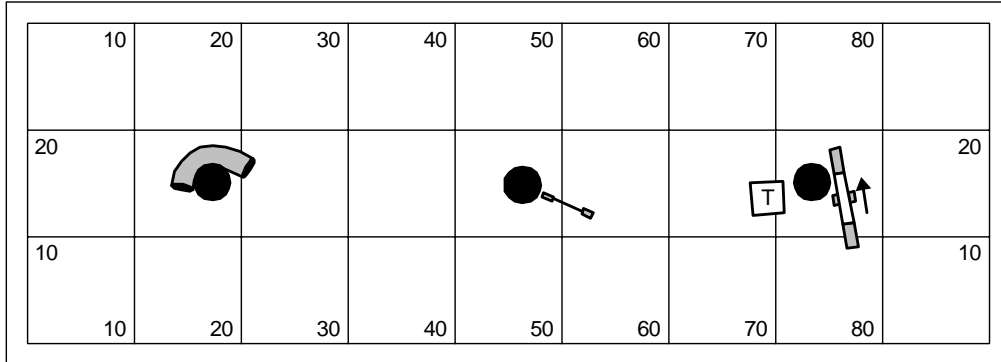

The illustration above shows poles that are nearly 3' in diameter. A pipe tunnel *might* be wrapped around one of these poles without losing visual acuity for the dog. And a jump *might* be abutted against the pole, particularly if the flow of the dog's path wraps away from the pole, and not around it. Certainly a smaller pole would provide better visual acuity for the dog.

In the case of using a pipe tunnel around the pole... it's very important that the pipe tunnel wrap around the pole. A u-shaped pipe tunnel backed *against* the pole is a recipe that is likely to cause some poor dog a concussion and should be avoided at all costs.

The third example shown in the illustration has a table on one side and a teeter on the other side. These scenarios should be avoided at all costs. It's probably not a good idea for the fabric of a collapsed chute to be too near to a pole either.